

# IMPORTANT, SAVE FOR FUTURE REFERENCE: READ CAREFULLY

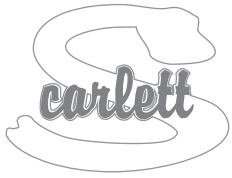

Baby cot with retractable side

## Instructions for assembly and use of the cot

2850 Scarlett Dominik, material - pine, color - natural (varnish)



### Parts:

- 1 – longer screw (8x)
- 2 – shorter screw (8x)
- 3 – roller nut (8x)
- 4 – lower plastic holder. (2x)
- 5 – middle holder plastic. (4x)
- 6 – upper plastic holder. (2x)
- 7 – fuse plastic. (1x left, 1x right)
- 8 – metal rod (2x)
- 9 – Allen key (1x)

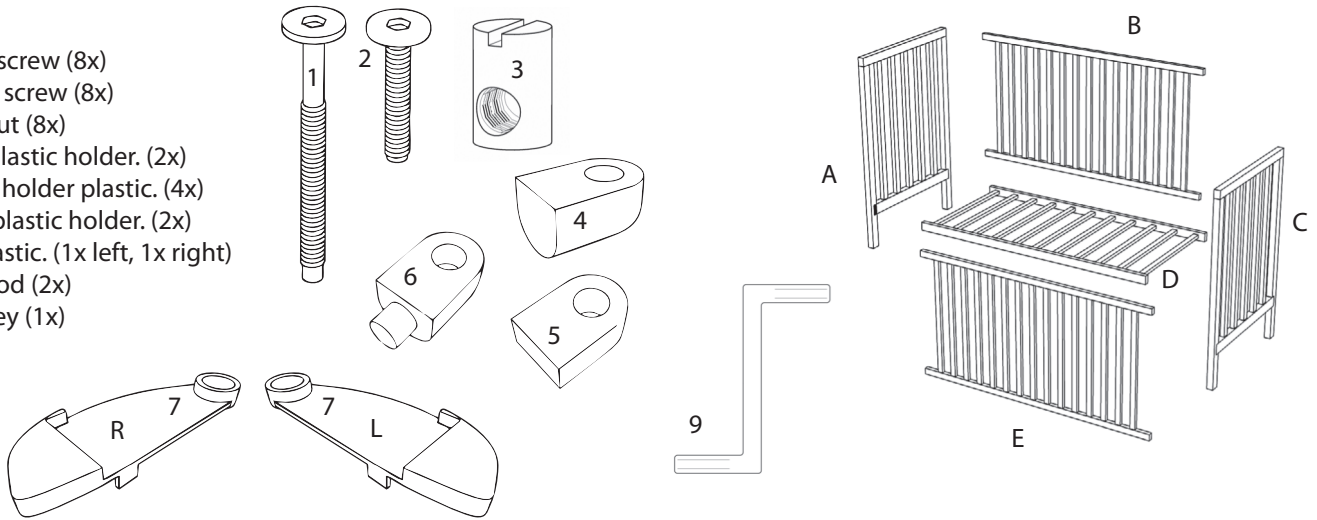

**1.**  
Using screws (1) and roller nuts (3), connect the front (A, C) and side parts (B)

**2.**  
Screws (1) and roller nuts (3) attach the grate (D). You can choose upper or lower position. **Roller nuts (3) when connecting to the sidewall they always put in the cribs from below the grate is not allowed the grate rotates, there is a risk of damage grate.**

**3.**  
Attach the screws (2) to the lower brackets (4) in the lower part of the legs of both front walls and slide through into the pull-in side (E). Drilled holes metal rods (8), in the middle with threaded middle holders (5).

**4.**  
Insert the rods (8) into lower brackets (4) and fasten the screws (2). middle brackets (5) to crib bed (A, C)

5.

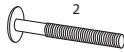

Put the fuses (7) on the upper one holders (6), slide onto the rods and fasten with screws (2) to the foot of the cot

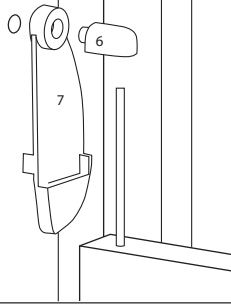

The legs of the cot are not pre-drilled for possible mounting of castors.



The wheels are not part of the crib and their assembly and use of the crib with wheels is at your own risk.

#### Instructions for using the pull-down side

In the raised position, the side of the cot is suspended on the surface of the fuses (7). To retract the side, lift it slightly, deflect the fuses and the side will lower slightly. After each manipulation of the pull-up side, make sure that the side is properly secured after being pulled up.

#### Notice:

a depth of at least 20 cm must remain between the upper surface of the mattress and the upper edge of the long side. In the lower position of the grid 50 cm. This is indicated by a line on the forehead cots. So it is not a defect product, but for the European requirement standards ČSN EN 716-1+AC (910606)

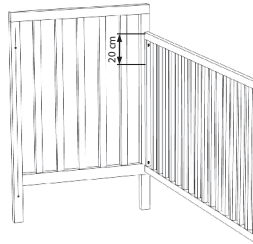

#### Recommendation:

In the event that the plastic sleeves become loose at the feet of the crib, we recommend gluing them to wood to prevent there were no wheels falling out and possible the leg of the cot.

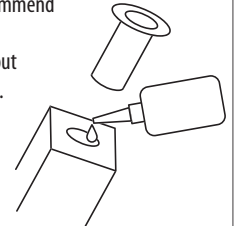

## WARNING / NOTICE

**with the sideboard in the lower position, do not let the child move freely around the room without supervision, there is a risk of suffocation under the lower edge of the lowered sideboard!**

#### Notice

- Warning: Keep in mind the risk of open fire and other sources of strong heat, e.g. electric heating, gas fire, etc. in close proximity to the cot;
- Caution: Do not use the crib if any part is broken, torn or missing and use only manufacturer approved replacement parts;
- Warning: Do not leave anything in the cot or place the cot near another product that could provide foot support or pose a suffocation or strangulation hazard, eg ropes, blind/curtain cords
- Warning: Do not use more than one mattress in the crib.

#### Usage

- The cot is ready for use, only after verifying that the locking mechanisms are fully functional before using the cot
- The height of the bottom is adjustable, the lowest position is the safest and should be used whenever the child is able to sit up on their own
- If you leave the child unattended in the crib, always make sure that the sides are movable in the closed position.
- Removable guides for moving the base are not used for this type of crib. The grating is positioned using screws in pre-drilled holes.
- Assembly drawing, description of individual parts and necessary tools for assembly can be found on page 1 of this manual.
- The thickness of the mattress must be such that the internal height (from the surface of the mattress to the top edge of the cot frame) is at least 500 mm in the lowest position of the bottom of the cot and at least 200 mm in the highest position of the bed bottom.
- The notches on the leg of the crib determine the maximum thickness of the mattress that can be used in the crib.
- The size of the mattress used in the crib must be such that the gap between the mattress and the sides, mattress and headboards will not exceed 30 mm.
- All fasteners must be properly tightened and must be checked regularly during use of the crib as needed.
- Keep the crib clean only with a cotton cloth slightly moistened in clean water without any chemical agents.
- To avoid injury from falling, the crib must not be used if the child is able to climb out of the crib.

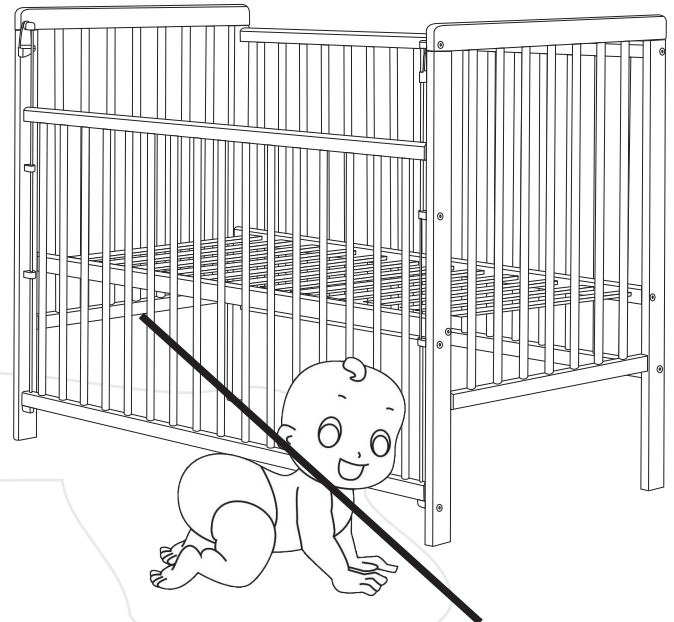

#### Packaging

- To avoid the risk of suffocation, remove the packaging material from the reach of infants and children (foils, plastic, cardboard, etc.).

#### Information for customers

- The cot is assembled on a flat surface, leave the screws loose during assembly, only tighten them firmly after the entire cot is assembled. During use, it is necessary to check these screws, in case of loosening, tighten them.
- The cot is treated with surface treatment. The paints used are harmless to health and meet the requirements of Ministry of Health Decree No. 84/2001 Coll. placed on products with lacquered surface treatment for children under 3 years of age.
- The crib is made according to the requirements of the Czech standard ČSN EN 716-1+AC (910606) and European EN 716-1:2017+AC:2019.**
- Notice of the minimum internal height requirement (i.e. the height between the upper surface of the mattress to the upper edge of the sideboard): 50 cm at the lowest position of the slat; 20 cm at the highest position of the grate. Any cuts on the leg of the cot indicate the maximum height of the upper edge of the mattress in the upper position of the slat and are not a defect in the product.

Zdzislaw Krajewski - Scarlett  
 Drahenská ul. 500, Novosedlice u Teplic  
 tel.: +420 417 535 770, www.scarlett.cz  
 IČ: 627 44 763